

 **Matsura**

Horizontal Machining Center

H.Plus-400



MAXIA
Innovation by  Matsura

Matsuura H.Plus-400

A dedicated 400mm square Pallet Horizontal – from Matsuura Legendary Matsuura Productivity – Rapid Return on Investment

Responding to our global customer base for a dedicated 4 axis 400mm square multi-pallet horizontal, Matsuura are proud to release the all new **H.Plus-400** into our family of renowned **H.Plus** Series machines. Conceived & developed utilising our many decades of experience creating world beating horizontal machining technology, the all new **H.Plus-400** has inherited all of the attributes of its siblings & predecessors; unerring accuracy, proven reliability, unrivalled productivity, tailorable suite of options and assured unmanned running.

Expandable as your business grows

Vast array of proven cost effective tool, pallet and automation options – tailored to your current and future production requirements.

Ergonomically designed to maximise output

With an operator, or integrated into an unmanned production environment, the **H.Plus-400** is designed & built around ease of use to minimise all non-productive time & to optimise spindle utilisation. New NC features include; Touch Screen, email functionality, on-screen manuals & enhanced **MIMS** software.

MAXIA Spindle as Standard

Matsuura – the pioneers of leading spindle technology are rightly proud of our **MAXIA** spindle technology supplied as standard with the **H.Plus-400**. Matsuura **MAXIA** spindles offer superb operation and reliability – from aluminium machining to hard to cut steels & exotic materials.

High Speed Drives, High Accuracy Precision – Maximum Productivity

Rapid traverse rates of 60m/min⁻¹ are achieved on X / Y / Z axes, delivering rapid operation & minimising non-productive non cutting time. The B axis is equipped with a proven DD (Direct Drive) motor, with Matsuura's revolutionary DCS (Direct Clamping System) and ADC (Automatic Acceleration / Deceleration System) supplied as standard, massively reducing non-productive indexing & positioning time.

Compact design smallest in its class

With shop floor real estate at a premium the world over, only 8.6m² of floor-space is required for the standard **H.Plus-400** machine – the smallest in its class of true 400mm square pallet horizontals.

Maximum workpiece size

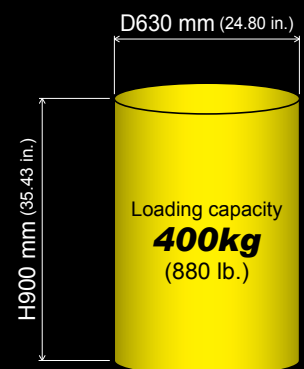

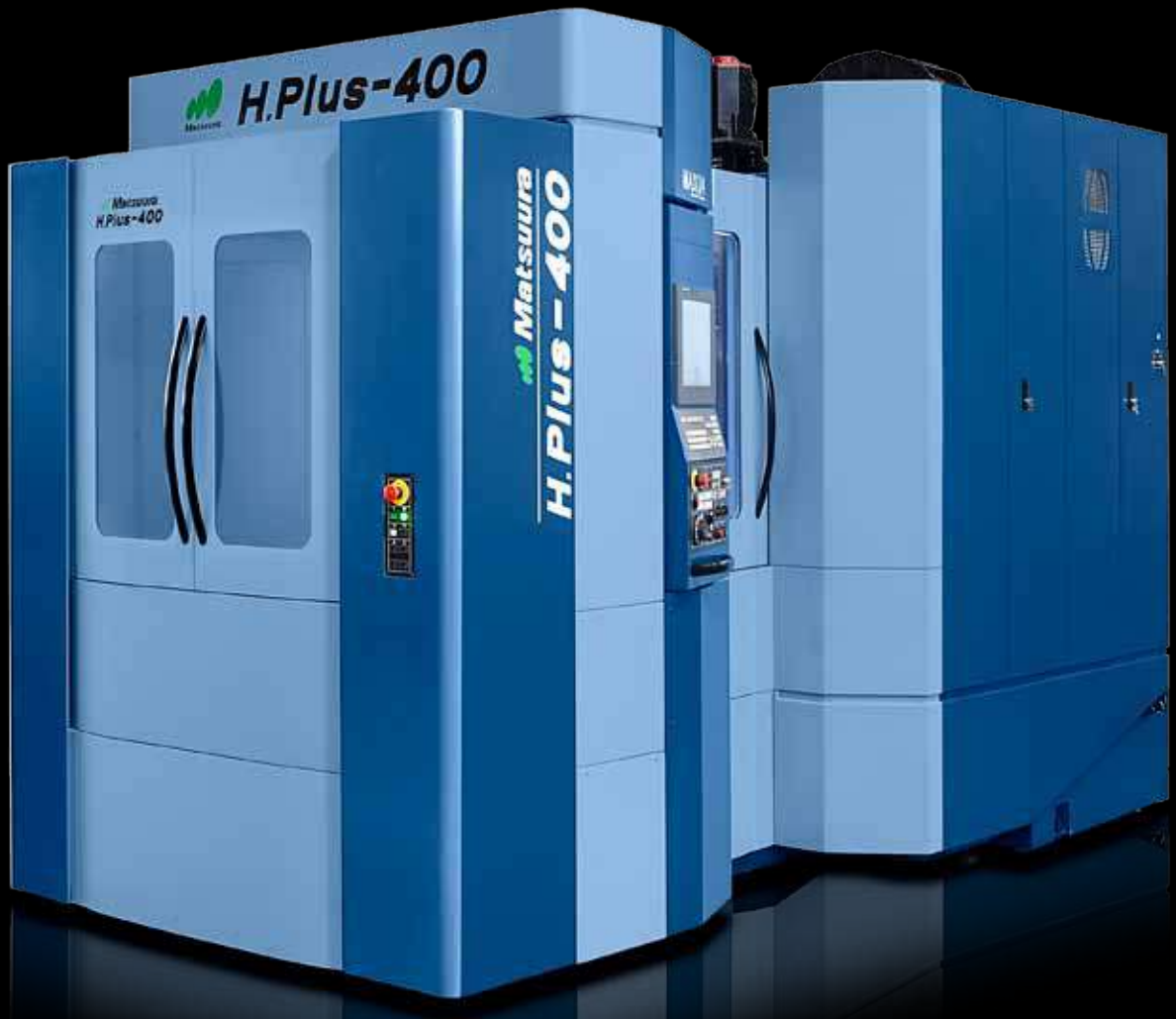

MAXIA
Innovation by  Matsuura

Advanced Capability – Traditional Matsuura Quality

Legendary **H.Plus** Series Rigidity

Inheriting all of the traditional design and build knowledge from our world renowned **H.Plus** Series horizontals, the **H.Plus-400** is an exceptionally rigid machining platform – as you would naturally expect from Matsuura.

Maximum workpiece size	D630× H900 mm (D24.80× H35.43 in.)
Loading capacity	400 kg (880 lb.)
Travel (X/Y/Z)	560 / 640 / 640 mm (22.04 / 25.19 / 25.19 in.)
Feedrate (X/Y/Z)	60 / 60 / 60 m/min (2.36 / 2.36 / 2.36 ipm)

Maximum workpiece size

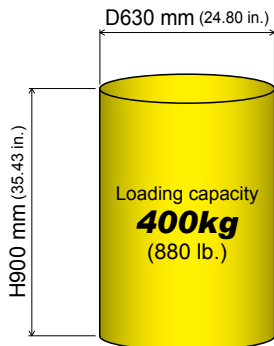

Axis configuration

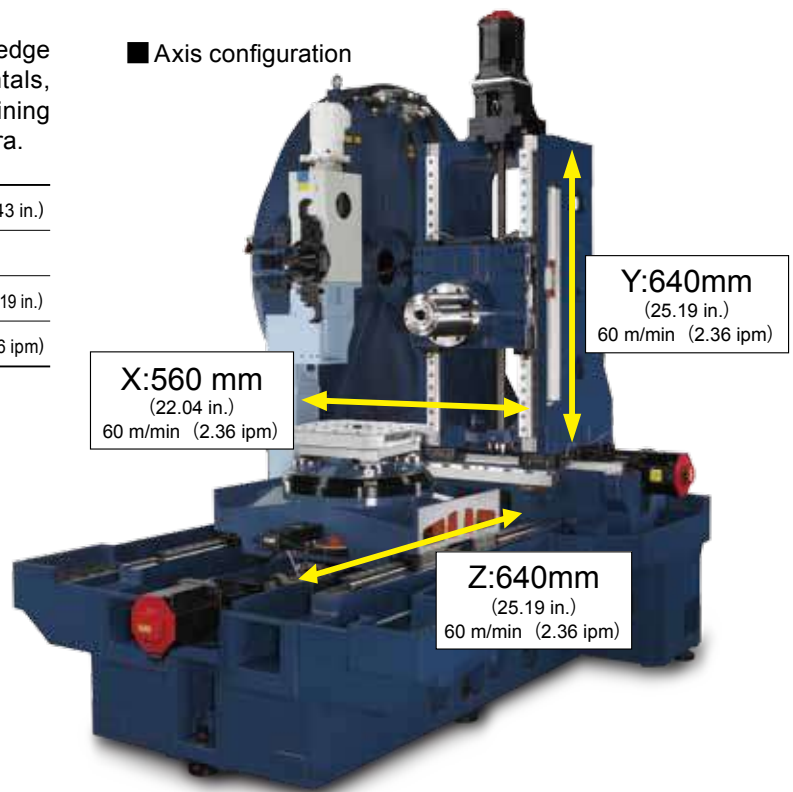

Designed for ease of use

The operator door to the cavernous machining enclosure offers 640mm access with the pallet center only 500mm away.

From the operator door to the pallet center	500 mm (19.68 in.)
Operator door opening width	640 mm (25.19 in.)
From the floor to the pallet top surface	1,050 mm (41.33 in.)

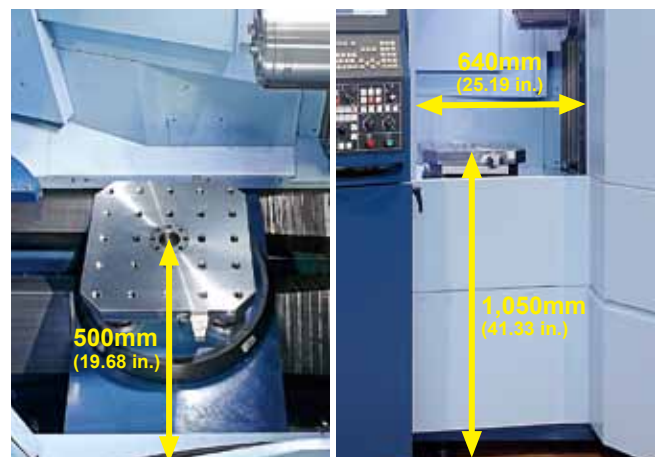

Tool Stations Expandable for Maximised Unmanned Running

60-tool ATC as standard

A proven & reliable 60 tool station ATC magazine (drum type) is the standard for the new **H.Plus-400**. **MIMS** functionality assures rapid & smooth tool set-up.

Tool change time (tool-to-tool)	6 kg (13.2 lb.) or less	0.9 sec
	6 kg (13.2 lb.) and more	1.4 sec
Indexing time from the tool change position	Longest (T1→T31)	10.7 sec
	Shortest (1pot)	7.1 sec
Tool selection method	Fixed address system	



ATC Options: Matrix Magazines for maximum unmanned production

Option

High capacity type	A maximum of 330 tools can be stored.
High speed type	A maximum of 294 tools can be stored. By optimizing the tool rack arrangement, the next tool waiting time can be shortened by up to 34%, compared with existing models.

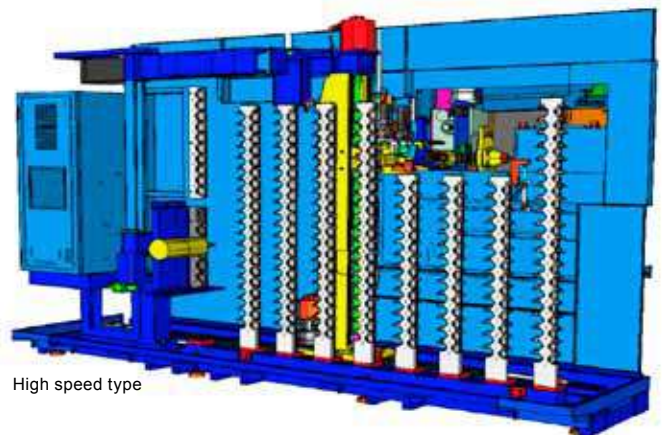

High speed type

Maximum tool weight: 10 kg,
maximum tool length: 350 mm

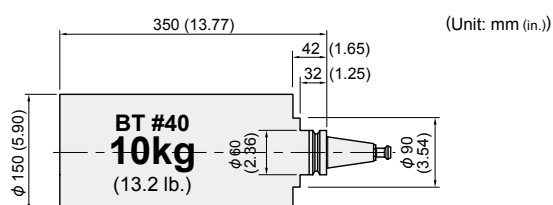

*Common to the drum magazine and Matrix magazine



Expandable for Maximised Unmanned Running – APC Multi Pallet System

Two types of pallet systems available

Floor pallet system (PC6) or tower pallet system (PC12) available as an option

PC6 Floor pallet system

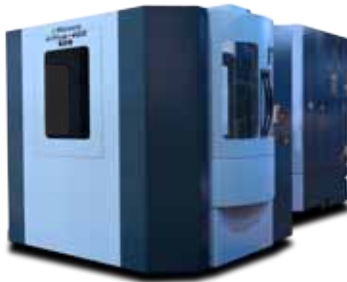

PC12 Tower pallet system



PC12 Floor plan (Unit: mm (in.))

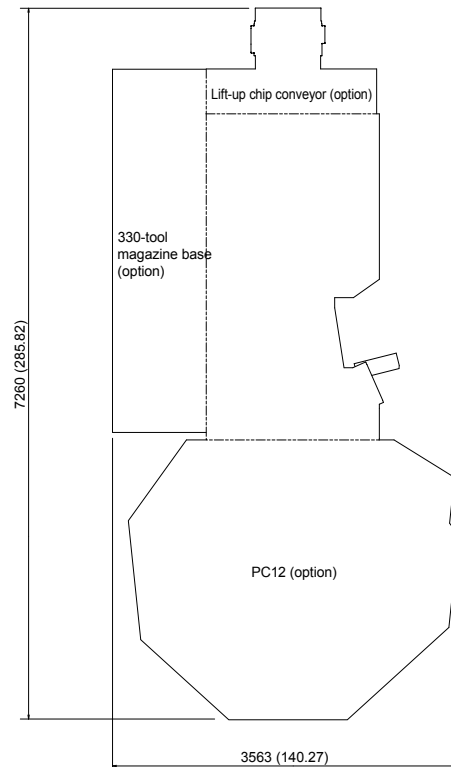

Thermal displacement compensation

The thermal displacement compensation function monitors the temperature of major machine components, such as the spindle, ball screws, bed or column, automatically calculates the amount of compensation, and feeds it back to the NC controller. In addition, an environmental thermal displacement compensation function is newly employed to compensate deformation of the machine that may be induced by room temperature changes.

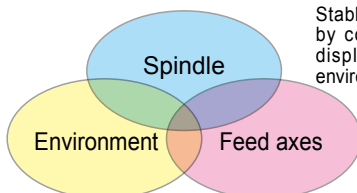

Stable machining accuracy is obtained by combining three kinds of thermal displacement compensation: spindle, environment, and feed axes (X/Y/Z).

* The X/Y/Z thermal displacement compensation function can be used on the machine with no scale feedback specification.

Pressure supply system for fixtures

Pressure supply ports for fixtures through the pallet are available as an option.

* A pressure supply source, solenoid valves, pressure switches, gap sensors, joints and hoses must be prepared by the customer.

	Number of ports	Pressure (MPa)
1. Work station side	8 ports	Max.19.6
2. Machine side	4 ports: B-axis rotary indexing (2 ports: B-axis 1-degree indexing)	Max.19.6

MAXIA Spindle

15,000 min⁻¹ as Standard

Spindle

The BT40 MAXIA Spindle is renowned for its enduring and unerring performance when cutting everything from aerospace aluminium, to hardened steels to exotic materials. Matsuura's own Thermal Displacement Compensation Function assures repeatability in cut time and again over long production runs

Spindle taper	15,000min ⁻¹	20,000min ⁻¹
BT40 (BT dual contact type)	Standard	Option
HSK-A63	Option	Option

MAXIA Spindle

Fabricated in a dedicated clean room to ensure that spindle runout at the mouth is reduced to less than 1 micron. Grease lubrication (automatic greasing type) is employed for minimal maintenance, low-air consumption, and environmental protection. Thermal displacement, vibration and noise are reduced to the minimum and contribute to high precision machining.



Spindle motor power & torque diagram

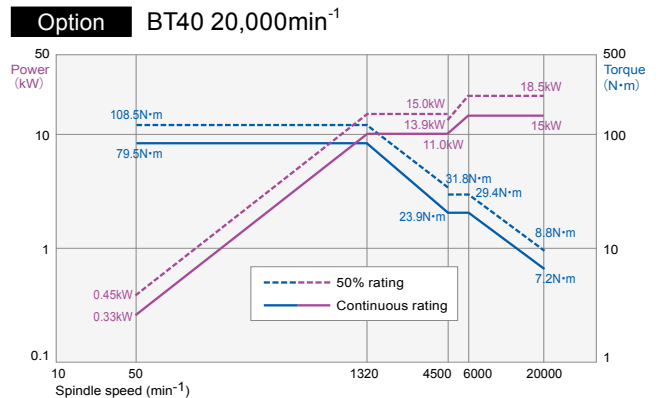
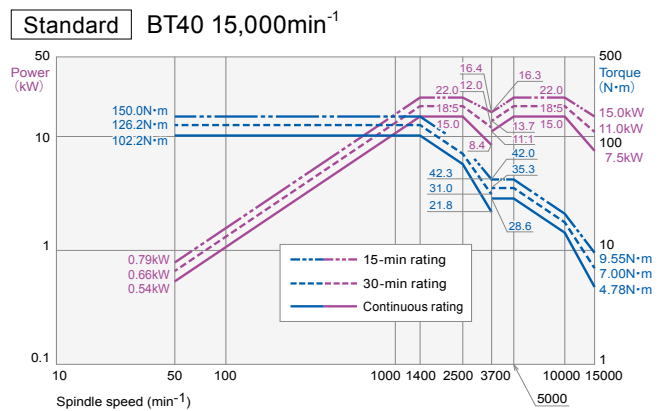

■ Cutting test results (BT40 15,000min⁻¹)

(in.)

	Part material	Tool size	Cutting width Cutting depth	Spindle speed	Cutting feed rate	Cutting capacity		Part material	Tool size	Spindle speed	Cutting feed rate	Cutting capacity
	A5052	Ø80mm (3.14) 3 blades	W=70mm (2.75) D=5mm (0.19)	5,500 min ⁻¹	8,000 mm/min (314.96)	2,800 cc/min		A5052	Ø35mm (1.37)	1,500 min ⁻¹	700 mm/min (27.55)	673 cc/min
	S45C	Ø80mm (3.14) 5 blades	W=70mm (2.75) D=3mm (0.11)	1,120 min ⁻¹	2,800 mm/min (110.23)	588 cc/min		S45C	Ø35mm (1.37)	1,300 min ⁻¹	330 mm/min (12.99)	317 cc/min
	A5052	Ø25mm (0.98) 2 blades	W=22mm (0.86) D=6mm (0.23)	15,000 min ⁻¹	11,000 mm/min (433.07)	1,452 cc/min		A5052	M36 × P4.0	100 min ⁻¹	400 mm/min (15.74)	
	S45C	Ø20mm (0.78) 4 blades	W=3mm (0.11) D=35mm (1.37)	5,500 min ⁻¹	5,500 mm/min (216.53)	578 cc/min		S45C	M30 × P3.5	100 min ⁻¹	350 mm/min (13.77)	

* The above data is based on actual cases. Depending on conditions, actual results may differ.

DD Motor Drive 4th-axis Table

Rotary indexing table with a DD motor

A non-contact, high-speed, high-acceleration, high precision DD motor (100 min⁻¹) is used for driving the 4th axis. This motor ensures low noise, superb unerring performance & trouble-free operation, and is virtually maintenance free.

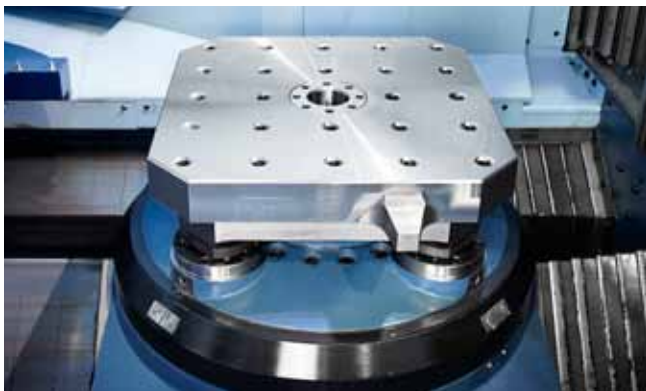

ADC (Automatic Acc. & Dec. Control)

Automatic acceleration/deceleration control function

The B-/Z-axis acceleration/deceleration can be automatically tuned during ATC operation according to the moment of inertia applied to the workpiece. Indexing time can be reduced by up to 40%.

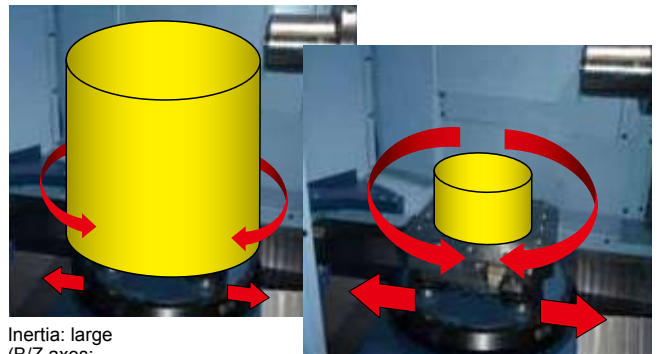

Inertia: large
(B/Z axes:
normal acceleration/deceleration)

Inertia: small
(B/Z axes:
optimal acceleration/deceleration)

DCS (Dynamic Clamp System)

The key to shorter indexing times is the table clamping/unclamping time.

Matsura's DCS function is the world's first revolutionary clamping system. The load level applied to the DD motor is monitored, and the table is clamped only when the load level has exceeded the setting value. The table remains unclamped even during machining as long as the load level is within the preset load range.

- Within the preset load range ⇒ Machining with the table unclamped (M21 and M22 skipped for light machining)
- Load range exceeding the setting value ⇒ Machining with the table clamped (M21 and M22 not skipped for heavy machining)

■ Light machining

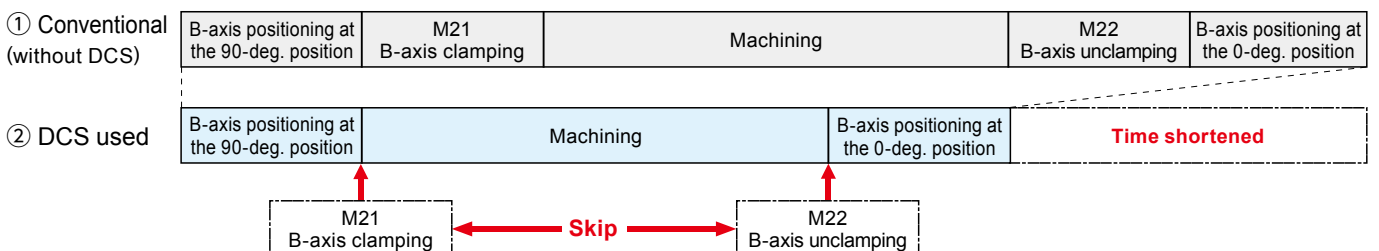

MIMS with New Features for Safety and Security of Machining

MIMS Matsuura Intelligent Meister System

Digitized Meister knowledge, skills and ingenuity

Matsuura's unique interface to maximize rapid operation and usability

Environment

Eco Meister

Power saving

- Power cut-off function
- Energy-saving devices installed

Accuracy

Thermal Meister

Stable accuracy

- Spindle thermal displacement compensation
- X/Y/Z thermal displacement compensation
- Environmental thermal displacement compensation

Simple

Operability Meister

Fuss-free simple operation

- Tool setup support
- Workpiece setup support

Secure

Reliability Meister

Machine downtime reduction

- Preventive maintenance support
- Failure cause analysis
- Electronic manuals
- E-mail function

E-mail function

At the occurrence of an alarm during operation, an e-mail message to notify the alarm can automatically be sent to the registered e-mail addresses. The operating status or machining progress status notification is also possible.

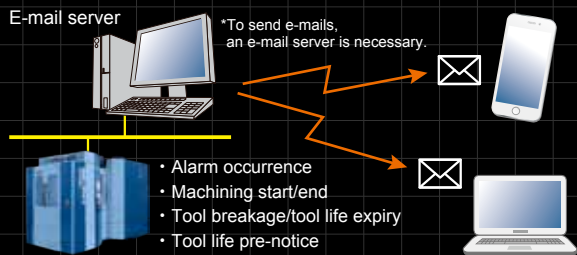

A maximum of 10 e-mail addresses can be set for each notification item.

15-inch touch panel screen adopted

The machine is equipped with a new operating system that features a 15-inch touch panel. Icons required for operation, setup and maintenance are displayed on the screen. Screen display can be switched by single-tapping, and can be customized as needed.



Electronic manuals

Electronic manuals can be viewed on the main operation panel. Search features and bookmarks ensure quick access to the information you are looking for.



Standard Machine Specifications

■ Movement and Ranges		
X-axis stroke (column right/left)	mm (in.)	560 (22.04)
Y-axis stroke (head up/down)	mm (in.)	640 (25.19)
Z-axis stroke (pallet back/forth)	mm (in.)	640 (25.19)
B-axis rotation angle (rotation on the Y axis)	deg	360
■ Table (Pallet)		
Working surface (X × Y)	mm (in.)	400 × 400 (15.74 × 15.74)
Loading capacity	kg (lb.)	400 (880)
Max. part size	mm (in.)	φ 630 × H 900 (φ 24.80 × H 35.43)
■ Spindle		
Spindle speed	min ⁻¹	50 - 15000 (Grease lubrication)
Type of spindle taper		7/24 taper #40 (BT dual contact type)
Spindle bearing inner diameter	mm (in.)	φ 80 (3.14)
Spindle motor output	kW	AC 15 / 22 (low-speed coil: cont. / 15 min) AC 15 / 22 (high-speed coil: cont. / 15 min)
Max. spindle torque	N·m	150 / 1400min ⁻¹
■ Feed Rate		
Rapid traverse rate X / Y / Z	mm/min (ipm)	60000 / 60000 / 60000 (2362.20 / 2362.20 / 2362.20)
■ Automatic Tool Changer		
Type of tool shank		JIS B 6339 tool shank 40T
Pull stud		JIS B 6339 pull stud 40P
Tool storage capacity	tools	60 (drum type)
Max. tool diameter	mm (in.)	80 (3.14) 150 (5.90) (with restrictions including normal tools)
Max. tool length	mm (in.)	350 (13.77)
Max. tool mass	kg (lb.)	10 (22) (Total tool weight: 300 kg (660) or less, max. eccentric load: 50 kg (110) or less)
Method of tool selection		Fixed address system
Tool change arm		W-grip type

■ Automatic Pallet Changer		
No. of pallets		2
■ Power Sources		
Electrical power supply	KVA	37 (Depends on the optional features)
Power supply voltage	V	AC 200 / 220 ± 10% Transformer required for the voltage except above
Power supply frequency	Hz	50 / 60 ± 1
Compressed air supply	MPa	0.54 - 0.93
■ Tank Capacity		
Hydraulic oil tank	L	10
Coolant tank	L	530
Oil cooler tank capacity	L	10 (Total capacity: 15)
■ Machine Size		
Machine weight	kg (lb.)	10,200 (22,440)
■ NC System		
Control system		Matsura G-Tech 31i
■ Standard Accessories		
01. Total splash guard with top side cover 02. ATC magazine guard		
03. ATC auto door 04. Pallet magazine safety guard		
05. Pallet loading station 06. Safety guard for loading station (with interlock)		
07. Synchronized tapping function 08. AD-TAP function		
09. IPC function 10. Spindle oil cooler		
11. Spindle automatic grease supply unit 12. Auto grease supply unit for feed axes		
13. Swarf back disposal 14. Coolant unit		
15. Chip flow 16. Feed axis collision prevention (software OT)		
17. Spindle overload protection 18. M-code counter (9 kinds)		
19. Work light 20. Standard mechanical tools & tool box		
21. Machine color paint		
22. MIMS (Matsura Intelligent Meister System) Thermal Meister included		
23. Leveling bolts and plates (not for foundation)		
24. Software tool for memory card program operation & editing CD-ROM		
25. Spindle two-year warranty		

Floor Plan (Unit : mm (in.))

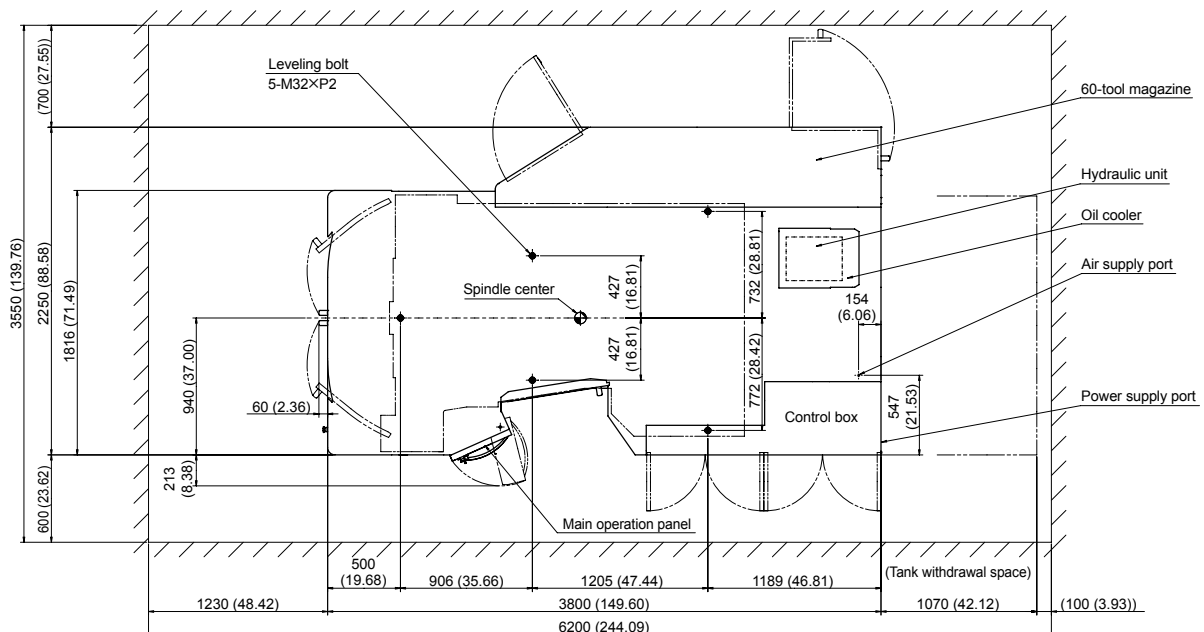

List of Fittings

○ : Standard ▲ : Option

■ Spindle	
15,000 min ⁻¹ (BT40, auto grease lubrication)	○
20,000 min ⁻¹ (BT40, auto grease lubrication)	▲
15,000 min ⁻¹ (HSK-A63, auto grease lubrication)	▲
20,000 min ⁻¹ (HSK-A63, auto grease lubrication)	▲
■ ATC (drum magazine)	
60 tools (#40, fixed address)	○
61 tools (#40, memory random)	▲
60 tools (HSK-A63, fixed address)	▲
61 tools (HSK-A63, memory random)	▲
■ ATC (Matrix magazine)	
120/160/200/240/280/330 tools (#40, high capacity type, 330-tool base)	▲
164/204/244/294 tools (#40, high speed type, 294-tool base)	▲
120/160/200/240/280/330 tools (HSK-A63, high capacity type, 330-tool base)	▲
164/204/244/294 tools (HSK-A63, high speed type, 294-tool base)	▲
■ High Accuracy Control	
Scale feedback X-/Y-/Z-axis (Heidenhain)	▲
■ APC	
PC2	○
PC6 (Floor pallet system)	▲
PC12 (Tower pallet system)	▲
■ Additional Axes	
1-degree index table (Curvic)	○
Matsuura rotary table, built-in DD motor type (max. 100 min ⁻¹)	▲
■ Coolant	
Coolant tank unit	○
Vacuum type through-spindle coolant A (7MPa)	▲
Vacuum type through-spindle coolant B (7MPa)	▲
Vacuum type through-spindle coolant C (2 MPa)	▲
Vacuum type through-spindle coolant C (7 MPa)	▲
Coolant flow checker (with through-spindle coolant)	▲
Ceiling shower coolant	▲
Ceiling shower coolant retrofitting	▲
Mist separator (without fire damper)	▲
Mist separator (with fire damper)	▲
Mist separator retrofitting	▲
Coolant temperature controller with 100-liter tank (separately installed, small size)	▲
Coolant temperature controller with 200-liter tank (separately installed, large size)	▲

■ Automatic Measurement, Tool Breakage Detection	
Automatic measurement / automatic alignment (optical)	▲
Tool breakage / full automatic tool length measurement (contact)	▲
Tool breakage / full automatic tool length measurement (laser)	▲
Automatic measurement (optical) & tool breakage (contact)	▲
Automatic measurement (optical) & tool breakage (laser)	▲
External tool breakage (60-tool drum magazine, contact)	▲
External tool breakage (Matrix magazine, contact)	▲
■ Chip Removal	
Total splash guard	○
ATC auto door	○
Spiral chip conveyor	▲
2 MPa external nozzle (with through-spindle coolant)	▲
7 MPa external nozzle (with through-spindle coolant)	▲
Lift-up conveyor (scraper, drum, spiral, water-based)	▲
Chip bucket	▲
Air blow for chip removal	▲
Part washing gun (on the machine side)	▲
Part washing gun (on the machine side) with no pump	▲
Part washing gun (on the APC side)	▲
■ Operation/Maintenance Support	
AD-TAP function	○
IPC function	○
MIMS	○
Auto grease supply unit for feed axes	○
Work light	○
Spindle runhour meter	○
Automatic operation runhour meter	○
Additional eight M functions	▲
Spindle load monitor function	▲
Weekly timer	▲
3-color signal light (red, yellow, green from top)	▲
Rotary wiper (air driven)	▲
Rotary wiper (electrically driven)	▲
Rotary wiper (electrically driven) retrofitting	▲
100 VAC socket 3 A	▲
Optional block skip addition 2 to 9	▲
Removable manual pulse generator	▲
DCS (Dynamic Clamp System) (to be combined with DD type rotary indexing)	▲
Pre-machining tool check function	▲
Pressure supply system for fixtures	▲
■ Safety Devices	
Matsuura safety specification	○
Automatic fire extinguisher	▲
■ Optional Package	
High-speed high-accuracy package	▲

Outline (Unit : mm (in.))

Front View

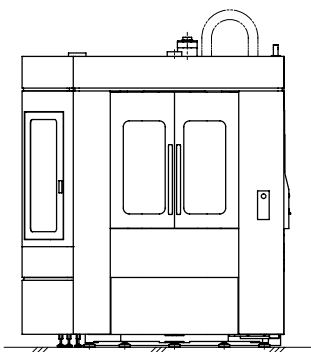

Right side view

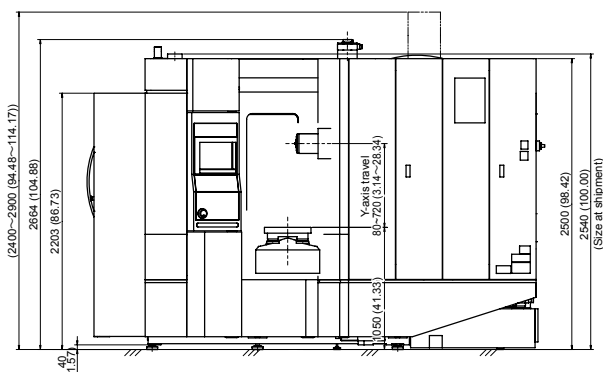

Pallet Surface (Unit : mm (in.))

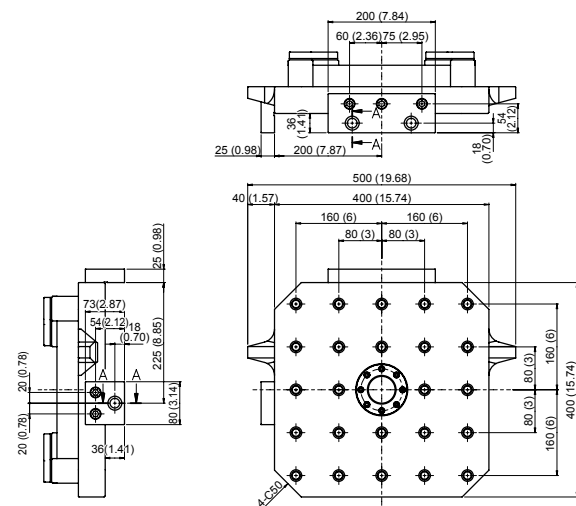



Matsuura

URL : <http://www.matsuura.co.jp/>

E-MAIL : webmaster@matsuura.co.jp

MATSUURA MACHINERY CORPORATION

1-1 Urushihara-cho Fukui City 910-8530, Japan

TEL : +81-776-56-8106 FAX : +81-776-56-8151

MATSUURA EUROPE GmbH

Berta-Cramer-Ring 21

D-65205 Wiesbaden-Delkenheim, Germany

TEL : +49-6122-7803-80 FAX : +49-6122-7803-33

URL : <http://www.matsuura.de/>

E-MAIL : info@matsuura.de

MATSUURA MACHINERY Ltd.

Gee Road, Whitwick Business Park, Coalville Leicestershire, LE67 4NH, England

TEL : +44-1530-511-400 FAX : +44-1530-511-440

URL : <http://www.matsuura.co.uk/>

E-MAIL : sales@matsuura.co.uk

Facebook : www.facebook.com/pages/Matsuura-Machinery-Ltd/427006380682983

MATSUURA MACHINERY GmbH

Berta-Cramer-Ring 21

D-65205 Wiesbaden-Delkenheim, Germany

TEL : +49-6122-7803-0 FAX : +49-6122-7803-33

URL : <http://www.matsuura.de/>

E-MAIL : info@matsuura.de

ELLIOTT MATSUURA CANADA INC.

2120 Buckingham Road Oakville Ontario L6H 5X2, Canada

TEL : +1-905-829-2211 FAX : +1-905-829-5600

URL : <http://www.elliottmachinery.com/>

E-MAIL : sales@elliottmachinery.com

MATSUURA MACHINERY USA INC.

325 Randolph Ave., St.Paul, MN 55102, U.S.A.

TEL : +1-651-289-9700

URL : <http://www.matsuurausa.com/>

E-MAIL : info@matsuurausa.com

-
- Product specifications and dimensions are subject to change without prior notice.
 - The photos may show optional accessories.



This product is subject to all applicable export control laws and regulations

